



# ***POWERBOX Pro***

## ***User Manual***

## Revision History

---

Revision NO.	Revision Date	Revision Reason
1.0	2022.3.11	1.First Published

---

---

## Content

<b>Statement of Law</b> .....	<b>2</b>
<b>Safety Precautions</b> .....	<b>3</b>
<b>Preface</b> .....	<b>4</b>
<b>1 Introduction</b> .....	<b>5</b>
1.1 Brief Introduction.....	5
1.2 Product Properties.....	5
1.3 Product identity definition.....	6
<b>2 Product Specification</b> .....	<b>7</b>
2.1 Size and Weight.....	7
2.2 Performance Parameter.....	7
2.3 Interface Definition.....	8
2.4 Battery Management System(BMS).....	10
2.4.1 Voltage Protection.....	10
2.4.2 Current Protection.....	10
2.4.3 Temperature Protection.....	10
2.4.4 Other Protection.....	11
<b>3 Installation and Configuration</b> .....	<b>12</b>
3.1 Preparations for installation.....	12
3.1.1 Environmental requirements.....	12
3.1.2 Tools and data.....	13
3.1.3 Technical preparation.....	13
3.1.4 Unpacking inspection.....	13
3.1.5 Engineering coordination.....	15
3.2 Equipment installation.....	15
3.2.1 Floor installation.....	16
3.2.2 Mounted on the wall.....	17
3.2.3 Electrical installation.....	19
3.2.4 Battery module DIP switch definition and description.....	24
3.2.5 Battery parameter settings on the inverter.....	29
3.2.6 Register on the website after installation.....	29
<b>4 Use, maintenance and troubleshooting</b> .....	<b>30</b>
4.1 Battery system usage and operation instructions.....	30
4.2 Alarm description and processing.....	31
4.2.1 Alarm and countermeasure for affecting system output.....	31
4.2.2 Alarm and countermeasure for non-affecting system output.....	32
4.3 Analysis and treatment of common faults.....	32

## Statement of Law

- Copyright of this document belongs to Daqin New Energy Tech (Taizhou) Co., Ltd.
- No part of this documentation maybe excerpted, reproduced, translated, annotated or duplicated in any form or by any means without the prior written permission of Daqin New Energy Tech (Taizhou) Co., Ltd.
- This product complies with the design requirements of environmental protection and personal safety. The storage, use and disposal of the products shall be carried out in accordance with the product manual, relevant contract or relevant laws and regulations.
- Customer can check the related information on the website of Daqin New Energy Tech (Taizhou) Co., Ltd. when the product or technology is updated.
- Please note that the product can be modified without prior notification.

# Safety Precautions

## Warning

- Please do not put the battery into water or fire, in case of explosion or any other situation that might endanger your life.
- Please connect wires properly while installation, do not reverse connect.
- To avoid short circuit, please do not connect positive and negative poles with conductor on the same device.
- Please avoid any form of damage to battery, especially stab, hit, trample or strike.
- Please shut off the power completely when removing the device or reconnecting wires during the daily use or it could cause the danger of electric shock.
- Please use dry powder extinguisher to put out the flame when encountering a fire hazard, liquid extinguisher could result in the risk of explosion.
- For your safety, please do not arbitrarily dismantle any component in any circumstances. The maintenance must be implemented by authorized technical personnel or our company's technical support. Device breakdown due to unauthorized operation will not be covered under warranty.



## Caution

- Our product have been strictly inspected before shipment. Please contact us if you find any abnormal phenomena such as device outer case bulging.
- The product shall be grounded properly before use In order to ensure your safety.
- To assure the proper use please make sure parameters among the relevant device are compatible and matched.
- Please do not mixed-use batteries from different manufacturers, different types and models, as well as old and new together.
- Ambient and storage method could impact the product life span, please comply with the operation environment instruction to ensure device works in proper condition.
- For long-term storage, the battery should be recharged once every 6 months, and the amount of electric charge shall exceed 80% of the rated capacity.
- Please charge the battery in 18 hours after it fully discharged or over-discharging protection mode is activated.
- Formula of theoretical standby time:  $T=C/I$  (T is standby time, C is battery capacity, I is total current of all loads).
- The surface of the product cabinet is affixed with a torn invalid label. Therefore, before opening the cover to change the DIP switch mode, you need to contact DYNESS and inform the product ID. DYNESS will record this battery ID and authorize the opening operation to be performed. Except for changing the DIP switch mode, no other operations are allowed. In the next stage, you can log in to apply for operations directly on the DYNESS website. Contact the authorized dealer or distributor of DYNESS for a new torn invalid sticker after tearing the original invalid label. When the operation is completed, paste the new one at a different position.

# Preface

## Manual declaration

Powerbox Pro Lithium Iron Phosphate Battery is external battery module which can store the electricity for home use. When you apply the grid or photovoltaic system as your powers supply, the product can collect electricity to charges the battery. When grid or photovoltaic system is power off , the product can supply electricity itself for your home loads.

Powerbox Pro User manual systematically elaborates device structure, parameters, basic procedure and method of installation, operation, maintenance.

## Safety Statement

- Only qualified trained professionals are allowed to install, operate, maintain the device.
- Please comply with local safety regulations and operational rules during installation, operation and maintenance, or it could cause unexpected injury or device damage.
- The safety declaration mentioned in the manual are only supplement context for your local safety regulations.
- The seller does not undertake any responsibility for device operations or usage of violating general safety requirements and safety standards.

## Sign explanation

User should clear the meaning of the caution sign below when configuring or operating Powerbox Pro series products.



## Caution

Neglecting the warnings might cause equipment failure.

---

# 1 Introduction

---

## 1.1 Brief Introduction

Powerbox Pro series is equipped with lithium iron phosphate battery for family use . We base on customer needs and market requirement to develop cutting-edge battery storage technology and offer this high quality product to supply stable electricity for all kind of user's devices. The product have long life span and can be applied in high temperature environment and take less space for installation.

Powerbox Pro series carries self-developed battery management system. When you apply the grid or photovoltaic system as your powers supply, the product can collect electricity to charges the battery. When grid or photovoltaic system is power off , the product can supply electricity itself for your home loads. Products also can be paralleled to build a multi-module system with more capacity to satisfy the longtime energy storage demand.

## 1.2 Product Properties

Powerbox Pro series energy storage product's anode materials are lithium iron phosphate, battery cells are managed effectively by BMS with better performance, the systems features as below:

- Comply with European ROHS, Certified SGS, employ non-toxic, non-pollution environment-friendly battery.
- Anode materials are lithium iron phosphate (LiFePO<sub>4</sub>), high safety performance with longer life span.
- Equipped with BMS (battery management system) mode with better performance, possesses protection function like over-discharge, over-charge, over-current, abnormal temperature.
- Self-management on charging and discharging, Single core balancing function.
- Intelligent design configures integrated inspection module.
- Flexible configurations allow parallel of multi battery for longer standby time.
- Self-ventilation with lower system noise.
- Less battery self-discharge, then recharging period can be up to 10 months during the storage.
- No memory effect so that battery can be charged and discharged shallowly.
- With wide range of temperature for working environment, -20°C ~ +55 °C, circulation span and discharging performance are well under high temperature.
- Less volume, lighter weight, seal grade up to IP65 embedding design for easier installation and maintenance.

### 1.3 Product identity definition

FIG1-1 Battery Energy Storage System nameplate

DYNESS ENERGY STORAGE SYSTEM		RECHARGEABLE LI-ION BATTERY	
Product	Powerbox Pro	CE	
Nominal Energy	10.24kWh		
Voltage Range	44.8V~57.6V		
Capacity/Voltage	200Ah/51.2V		
Max. Charging Current	100A		
Max. Discharging Current	100A		
Ambient Temperature	-10°C~50°C	S/N: <span style="border: 1px solid black; display: inline-block; width: 50px; height: 15px; vertical-align: middle;"></span>	
Protection Class	I		
IP Grade	IP65		
DAQIN NEW ENERGY TECH(TAIZHOU)CO., LTD.			



Battery voltage is higher than safe voltage, direct contact may cause electric shock hazard.



Be careful with your actions and be aware of the dangers.



Read the user manual before using.



The scrapped battery cannot be put into the garbage can and must be professionally recycled.



After the battery life is terminated, the battery can continue to be used after it recycled by the professional recycling organization and do not discard it at will.



This battery product meets European directive requirements.



## 2 Product Specification

### 2.1 Size and Weight

Table 2-1 Powerbox Pro Series Device Model

Product Series	Nominal Voltage	Nominal Capacity	Dimension (mm)	Weight (kg)	IP Level
Powerbox Pro	51.2V	200Ah	928×555×210	110	IP65

### 2.2 Performance Parameter

Table 2-2 Powerbox Pro performance parameter

Item	Powerbox Pro
Nominal Voltage(V)	51.2
Work Voltage Range(V)	44.8~57.6
Nominal Capacity(Ah)	200Ah
Nominal Energy(kWh)	10.24
Nominal Power(kW)	5.12
Peak Power(kW)	10.24
Max Charging Current(A)	100
Max Discharge Current(A)	100

## 2.3 Interface Definition

This section elaborates on interface functions of the front panel of the device.

Figure2-1 Powerbox Pro the sketch of front interface.

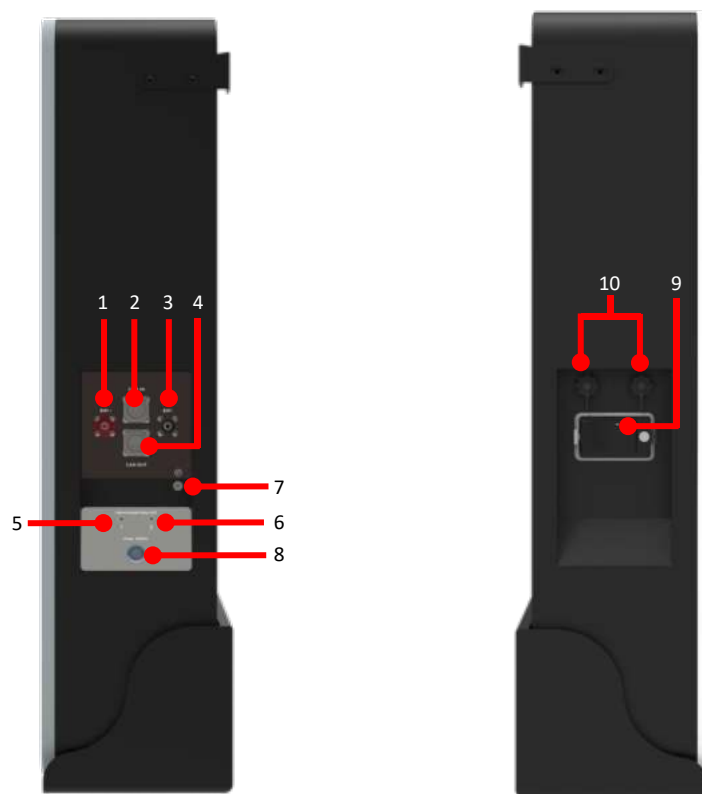







Table 2-3 Interface Definition

Item	Name	Definition
1	Positive socket	The battery DC output positive pole, which is connected to the positive pole of the inverter through the cable
2	COM IN	When the system is used independently: The CAN/RS485 socket is connected to the inverter CAN/RS485 interface through the communication cable. When the system is used in parallel: This CAN/RS485 communication socket is connected to the COM OUT interface of the previous Powerbox Pro through communication cable.
3	Negative socket	The battery DC output negative pole, which is connected to the negative pole of the inverter through the cable
4	COM OUT	When the system is used independently: This CAN/RS485 socket is a reservation interface

Item	Name	Definition
		When the system is used in parallel: This CAN/RS485 communication socket is connected to the COM IN interface of the next Powerbox Pro through communication cable. (Factory default CAN communication mode)
5	LED1	Module 1 status indicator light
6	LED2	Module 2 status indicator light
7	Ground connection point	Shell ground connection
8	Reset switch	Press the switch and the battery system turn on. When the battery is in the non-use state such as storage, transportation etc., it needs to be turn off by pressing the Reset switch button, and the battery system will automatically sleep after the device without external load and power for 72 hours.
9	DC circuit breaker	Circuit Protection
10	COM	Communication cascade port, support RS232

Table 2-4 LED status indicators

State	Protect/Alarm/ Normal	Led1	Led2	Directions
Shut down		off	off	All off
Stand-by/Charging/Discharging	Normal			Always on, $11\% \leq \text{SOC} \leq 100\%$
	Alarm			Always on, Corresponding module alarm or $0\% < \text{SOC} \leq 10\%$
	Protection			Flashing, (Corresponding module protection be activated / Over-discharge protection / Over-current protection / Temperature abnormality, etc.)
Other case	Alarm	Yellow, green and red flash alternately		All module address assignments in the system are incomplete
		The master LED1 yellow flash		Communication failure between batteries

## 2.4 Battery Management System(BMS)

### 2.4.1 Voltage Protection

#### **Low Voltage Protection in Charging:**

When any battery cell voltage or total voltage is lower than the rated protection value during discharging, the over-discharging protection is activated, and the battery buzzer makes an alarm sound. Then battery system stops supplying power to the outside. When the voltage of each cell back to rated return range, the protection is over.

#### **Over Voltage Protection in Charging:**

During charging stage, the system will stop charging when the total voltage of the battery pack is higher than rated value or the voltage of any single cell reaches the protection value. When total voltage or all cell back to rated range, the protection is over.

### 2.4.2 Current Protection

#### **Over Current Protection in Charging:**

When the charge current of any module  $> 90A$ , current limit protection mode is activated, current will be limited to  $1A$ , protection is removed after rated time delaying  $10S$ . Circulate like this until the current is lower than  $90A$ .

#### **Over Current Protection in Discharging:**

When the discharge current of any module is higher than  $100A$ , the battery buzzer alarms and the system stops discharging after  $15s$ . After protection, the discharging will restore in  $60s$  delay or immediately when there is charging current.



### **Caution:**

The buzzer sound alarm setting can be manually turned off on the background software, and the factory default is on.

---

### 2.4.3 Temperature Protection

#### **Low/Over temperature protection in charging:**

When battery's temperature is beyond range of  $0^{\circ}C \sim +65^{\circ}C$  during charging, temperature protection be activated, device stops charging. The protection is released when it back to rated range of working temperature.

**Low/Over temperature protection in discharging:**

When battery' s temperature is beyond range of  $-20^{\circ}\text{C}$  ~  $+65^{\circ}\text{C}$  during discharging, temperature protection be activated, device stops supplying power to the outside. The protection is released when it back to rated range of working temperature.

#### 2.4.4 Other Protection

**Short Circuit Protection:**

When the battery is activated from the off state, if a short circuit occurs, the DC circuit breaker will respond first. If the DC circuit breaker does not operate, the short circuit protection function of BMS will be activated automatically and cut off the device' s output.

**Self Shutdown:**

When device connects no external loads for over 72hours, device will dormant standby automatically.

**Caution**

The maximum operating current required for the electrical load shall be less than the maximum discharge current capacity of the battery.

---

## 3 Installation and Configuration

### 3.1 Preparations for installation

#### Safety Requirement

This system can only be installed by personnel who have been trained in the power-supply system and have sufficient knowledge of the power system.

The safety regulations and local safety regulations listed below should always be followed during the installation.

- All circuits connected to this power system with an external voltage of less than 48V must meet the SELV requirements defined in the IEC60950 standard.
- If operating within the power system cabinet, make sure the power system is not charged. Battery devices should also be switched off
- Distribution cable wiring should be reasonable and has the protective measures to avoid touching these cables while operating power equipment.
- when installing the battery system, must wear the protective items below:



The isolation gloves



Safety goggles



Safety shoes

#### 3.1.1 Environmental requirements

- Working temperature:  $-20\text{ }^{\circ}\text{C} \sim +55\text{ }^{\circ}\text{C}$ 
  - Charging temperature range is  $0\text{ }^{\circ}\text{C} \sim +55\text{ }^{\circ}\text{C}$ ,
  - Discharging temperature range is  $-20\text{ }^{\circ}\text{C} \sim +55\text{ }^{\circ}\text{C}$
- Storage temperature:  $-10\text{ }^{\circ}\text{C} \sim +35\text{ }^{\circ}\text{C}$
- Relative humidity: 5% ~ 85%RH
- Elevation: no more than 4000m
- Operating environment: Indoor or outdoor installation, sites avoid the sunlight and no wind, no conductive dust and corrosive gas.
- And the following conditions are met:
  - Installation location should be away from the sea to avoid brine and high humidity environment.
  - The ground for product arrangement shall be flat and level.
  - There is no flammable explosive materials near to the installation site.
  - The optimal ambient temperature is  $15\text{ }^{\circ}\text{C} \sim 30\text{ }^{\circ}\text{C}$
  - Keep away from dust and messy zones

### 3.1.2 Tools and data

Tools and meters that may be used are shown in table 3-1.

Table 3-1 Tool instrument

Screwdriver (Slotted、Phillips)	Multimeter
Torque wrench	Clamp current meter
Diagonal pliers	Insulation tape
Pointed nose pliers	Temperature meter
Pliers to hold the wire	Anti-static bracelet
Stripping pliers	Cable tie
Electric drill	Tape measure

### 3.1.3 Technical preparation

- Electrical interface check

Devices that can be connected directly to the battery can be user equipment, power supplies, or other power supplies.

- Confirm whether the user equipment, the PV equipment or other power supply equipment has the DC output interface, and measure whether the output voltage of the standby interface meets the requirements of the voltage range of table 2-2
- Verify that the maximum discharge current capacity of the user equipment, the PV equipment or other power supplies, the DC standby interface, and the maximum discharge current shall be greater than the maximum charging current of the products used in table 2-2.
- If the user equipment DC prepared interface maximum discharge capacity is less than the maximum charging current products using table 2-2, the user interface should have the power equipment of DC current limiting function, give priority to ensuring the normal work of user equipment.

- The security check







- Firefighting equipment should be arranged near the equipment, such as portable dry powder fire extinguisher.
- Automatic fire fighting system shall be provided for the case where necessary.
- Flammable, explosive and other dangerous materials placed beside the battery are prohibited.

### 3.1.4 Unpacking inspection



- When the equipment arrives at the installation site, loading and unloading should be carried out according to the rules and regulations, so as to prevent from being exposed to sun and rain.
- Before unpacking, the total number of packages shall be indicated according to the shipping list attached to each package, and the case shall be checked for good condition.

- In the process of unpacking, handle with care and protect the surface coating of the object.
- Open the package, the professional installation personnel should read the technical documents, verify the list, according to the configuration table and packing list, ensure objects are complete and intact. If the internal packaging is damaged, it must be inspected and recorded in detail.

Packing list is as follows:

 <p>Battery×1</p>	 <p>Battery bottom bracket ×1</p>	 <p>Support bracket ×2</p>
 <p>M6 bolt ×8 Fixing battery box with battery bracket</p>	 <p>Power cable ×1 pair connect battery with inverter</p>	 <p>Standard communication cable×1</p>
 <p>RJ45 Waterproof connector ×2</p>	 <p>Expansion screw ×8</p>	 <p>Positioning cardboard×2</p>



 <p>120 <math>\Omega</math> CAN resistor <math>\times 1</math></p>	 <p>User manual <math>\times 1</math></p>	
---	--	--

### 3.1.5 Engineering coordination

Attention should be paid to the following items before construction:

- Power cable specification.
- The power cable specification shall meet the requirements of maximum discharge current for each product.
- Mounting space and bearing capacity.
- Make sure that the battery has enough space to install, and that the battery rack and bracket have enough load capacity.
- Wiring.
- Make sure the power cable and ground wire are reasonable. Not easy to short-circuit, water and corrosion.

## 3.2 Equipment installation

The wall for battery installation shall be solid brick or cement wall with strong bearing capacity and wall thickness no less than 100mm.

Mounting space requirements:

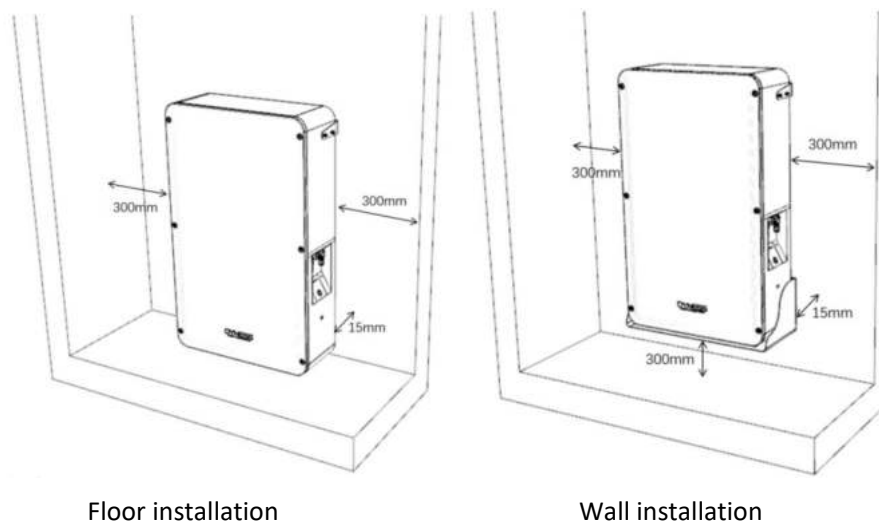
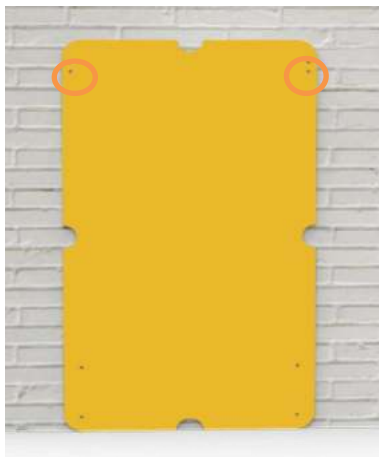

Table 3-2 Installation steps

<b>Step1</b>	System outage	Ensure that the battery is in a shutdown state
<b>Step 2</b>	Mechanical installation	1. Hanger mounting
		2. Equipment installation
<b>Step3</b>	Electrical installation	1. Connect the ground cable
		2. Electrical installation
		3. Connect inverter
		4. Communication interface connection

### 3.2.1 Floor installation

When the battery system is placed directly on the ground, a fixed support must be used to fix the top of the battery box on the wall.



1. Use the positioning cardboard (provided in accessory package) and mark the screw hole positions on the wall, as shown in the four holes on the left.
2. The bottom of board must be good connection with the ground level while marking the holes.



3. Press the marked position with the electric drill and trepanning 4 holes with a diameter of 10mm on the wall. The hole depth shall be greater than 70mm for fitting the expansion bolt of M6.



4. Fixing the expansion bolt M6 into the bottom of the hole on the wall.
5. Use the M6 bolt to fixing the Support bracket to the wall and control the torque at 6NM.
  
6. Carry the battery box to the installation site, and place it about 15mm away from the wall surface, fixing the Support bracket and the upper part of the battery box with M6 bolts.

### 3.2.2 Mounted on the wall

The following accessories need to be added when install the powerbox Pro on the wall.



Battery bottom bracket x1



Expansion screw x4



1. Use the positioning cardboard (provided in accessory package) and mark the screw hole positions on the wall, as shown in the four holes on the left.
2. The cardboard must be perpendicular to the ground while drawing the holes.
3. The bottom of the cardboard is about 300mm from the ground.
4. According to the position of the mark, 8 holes in diameter 10mm and depth of more than 70mm are hit on the wall with an electric drill, which are used for fitting expansion bolt M6.
5. Fixing the expansion bolt M6 into the bottom of the hole on the wall, and fix the Support bracket and Battery bottom bracket on the wall with M6 bolts, twisting force keeps 6NM.
6. Carry or hoist the battery box to the installed Battery bottom bracket. Fixing the Support bracket and the upper part of the battery box with M6 bolts, twisting force keeps 6NM. Then fixing the Battery bottom bracket and the bottom part of the battery box with M6 bolts, twisting force keeps 6NM.

### 3.2.3 Electrical installation

Before connecting the power cables, using multimeter to measure cable continuity, short circuit, confirm positive and negative, and accurately mark the cable labels.

Measuring method:

- Power cable check: select the buzzer mode of multimeter and detect the both ends of the same color cable. If the buzzer calls, it means the cable is in good condition.
- Short circuit judgment: choose multimeter resistor file, probe the same end of positive and negative pole, if the resistor shows infinity, means that the cable is available.
- After visual testing of power line is connection, the positive and negative poles of the battery shall be connected respectively to the positive and negative poles of the opposite terminal.

#### 1) Connect the battery box to the ground cable

Customer needs to prepare a M6 OT terminals and ground cables. Ground the battery shell as shown below. The sectional area of the grounding cable shall be at least 6mm<sup>2</sup> and the bolt locking torque is 6NM.

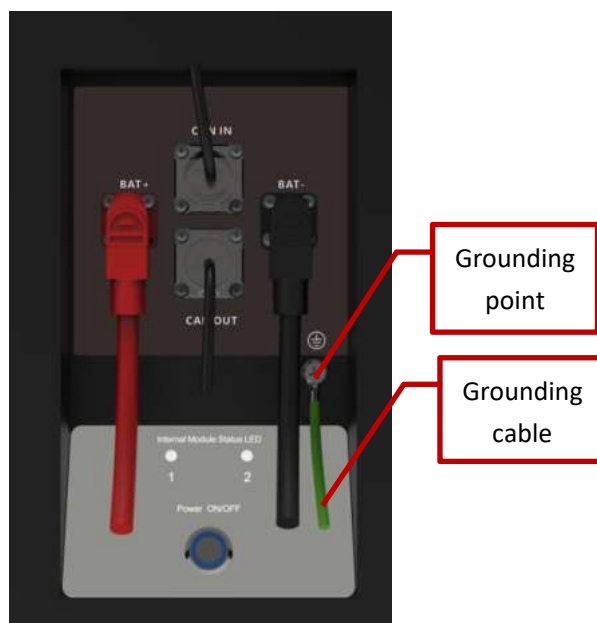

### Caution:

If there is any question during installation, please contact your dealer to avoid damage to the equipment.

## 2) Inverter Connection

- When the system is used independently:

Note: Before installation, please confirm whether the DIP switch mode of the master module in powerbox Pro is correct according to use's inverter communication specification. For specific DIP operation methods, please refer to "3.2.4 Battery module DIP switch definition and description." Except for the inverter specified by the customer's special requirements, the factory default DIP switch mode of master module is DIP Switch mode 1 (ADD: 0010). If the inverter is equipped with other DIP switch mode, open the front panel and Set DIP switch mode of the master module to the correct mode. Before opening the cover to operate, you must contact DYNESS and inform the ID of the product. DYNESS records this battery ID and authorizes the opening operation. Except changing the DIP switch mode, no other operations can be done.

- The battery is connected to the inverter, and it is required to use the dedicated power cable and communication cable (as accessories shipped with the cargo, the standard communication cable is a standard network cable. The applicable inverter is marked on the label of the network cable. If the inverter used by the customer is not covered by the standard communication cable, please contact DYNESS for the correct PIN Sequence) as follows:
  - Keep the battery system at power off state, connect the power cable to the interface on the input side of the inverter first, and then connect the power cable to the interface on the battery side.
  - The battery output interface is a quick connector, and the power cable (positive, negative) plug can be directly inserted into the battery socket. The power cable cross section is 25 mm<sup>2</sup>.

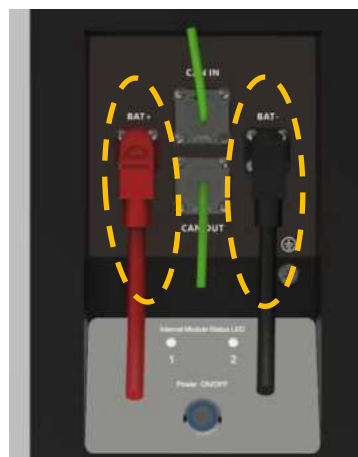

- Connection of Communication interface. Connect the CAN IN port of the battery to the CAN or RS485 communication interface of the inverter using the RJ45 cable.

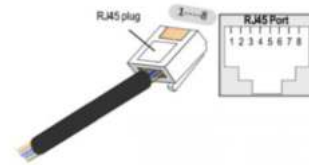
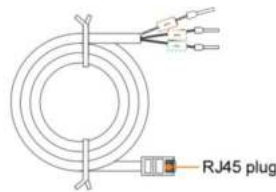
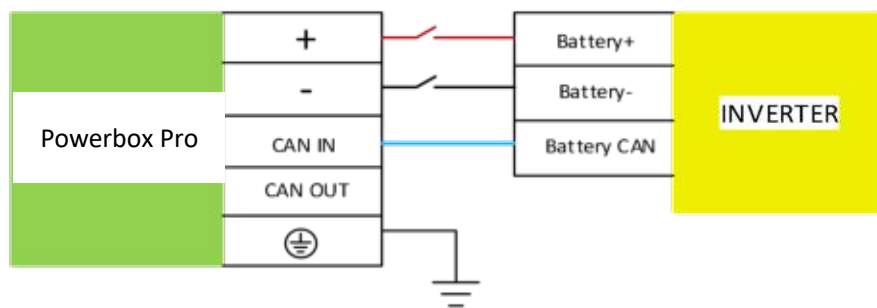
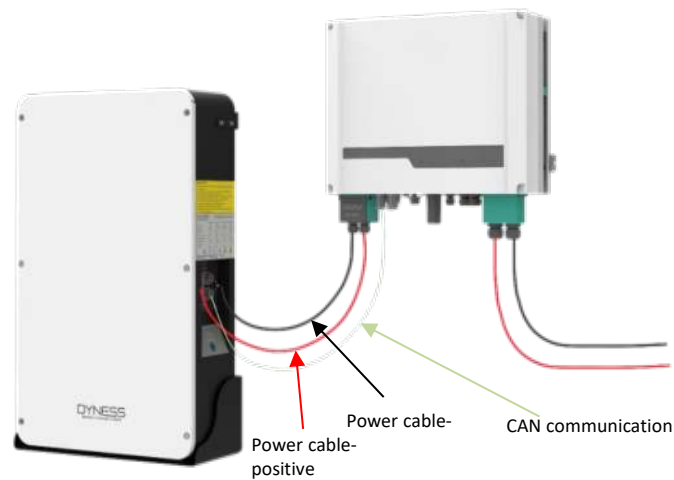

Table 3-3 Pin Definition

Foot position	Color	Definition
PIN1	Orange/white	485B
PIN2	Orange	485A
PIN3	Green/white	XGND
PIN4	Blue	CANH
PIN5	Blue/white	CANL
PIN6	Green	Reserved
PIN7	Brown/white	XIN
PIN8	Brown	Reserved



### 3) When the system used in parallel:

When the system is used in parallel, it supports up to 5 Powerbox Pro in parallel. According to the number of parallel system (Take 5 Powerbox Pro in parallel as an example), it needs to use: Power cable  $\times$  5 pair, Battery-Inverter communication cable  $\times$  1PCS, Battery-Battery communication cable  $\times$  4PCS, Distribution box  $\times$  1PCS. The over-current capacity of the distribution box should be much higher than the maximum nominal current value when the load is running.





**PINOUT of system parallel communication cable:**

PINOUT of Battery-Battery communication cable diagram shown as below:



BATTERY-Dyness



Pin	Color	Definition
1	Orange/white	4B_B
2	Orange	4B_A
3	Green/white	XGND
4	Blue	CAH
5	Blue/white	CAH
6	Green	X+V
7	Brown/white	XN
8	Brown	NC

INVERTER-GDWSOLIS/GROWATT/DEYE/RENAC/SMA/Sunsynk



Pin	Color	Definition
1	Orange/white	4B_B
2	Orange	4B_A
3	Green/white	XGND
4	Blue	CAH
5	Blue/white	CAH
6	Green	NC
7	Brown/white	NC
8	Brown	NC

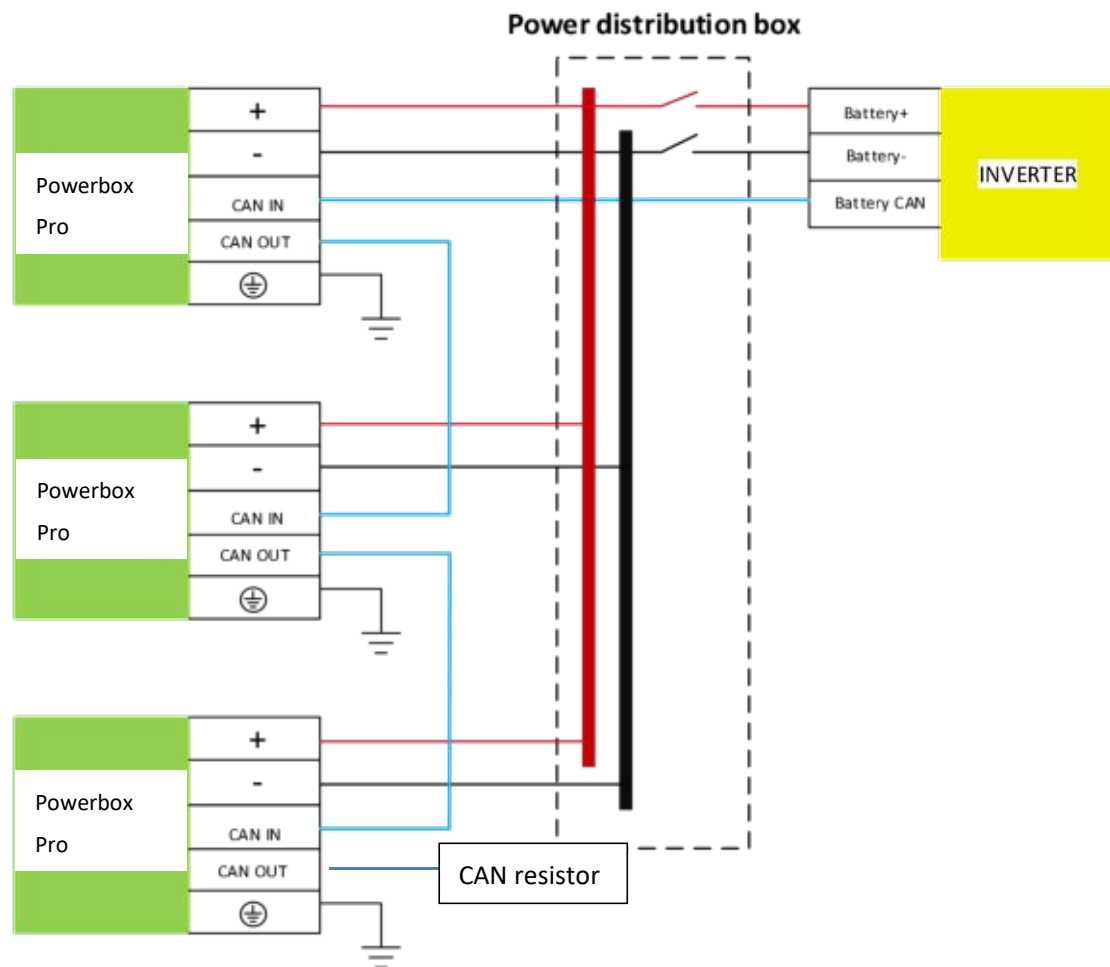

### 3.2.4 Battery module DIP switch definition and description

Table 3-4 DIP switch Definition

**DIP switch position (master communication protocol and baud rate selection)**

#1	#2	#3	#4
<b>Define different protocols; Distinguish between master and slave</b>			Baud rate selection
			OFF: CAN: 500K,485: 9600
			ON: CAN: 250K,485: 115200

**DIP switch description:**

For Powerbox Pro series system, the master module at the bottom of cabinet , the other modules are slaves.

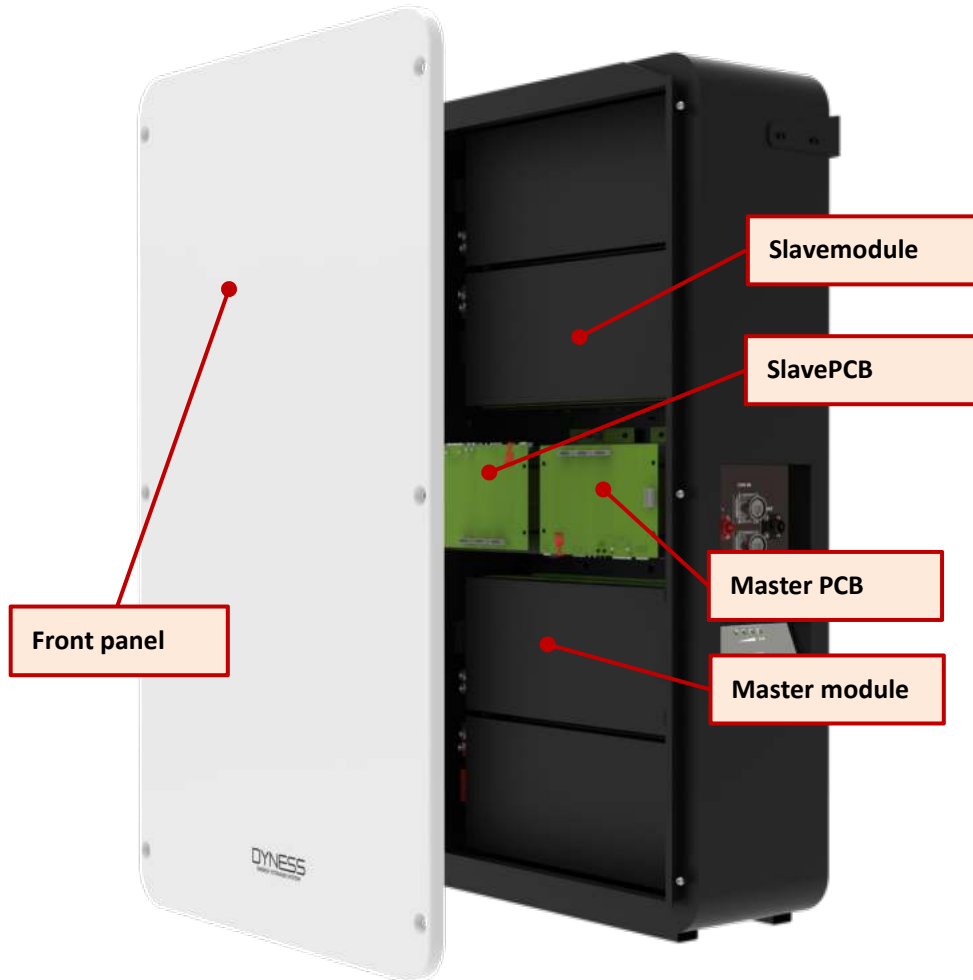

When the batteries are connected in parallel, the master communicates with the slaves through the CAN interface. The master summarizes the information of the entire battery system and communicates with the inverter through CAN or 485.

Introduction of the initial state of DIP switch of the internal modules of Powerbox Pro with DIP switch.

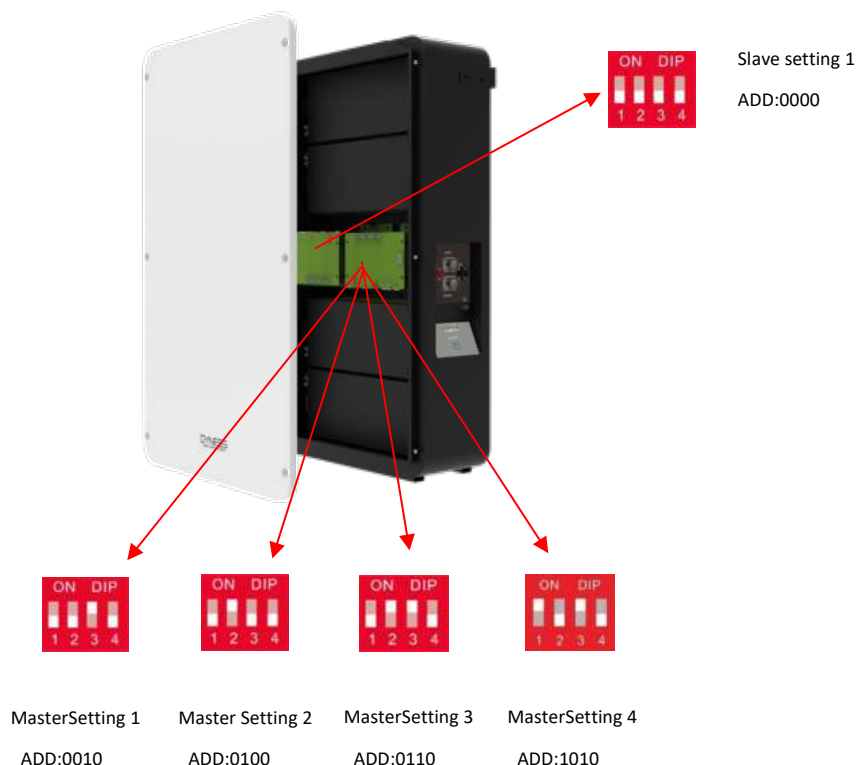

For different inverter model, you need to set different DIP mode:

(1) Ensure the communication cable that communicates with the inverter is correct.  
 (2) When the battery works with GOODWE、Solis、LUX、Sofar、DEYE、VICTRON、IMEON、Sungrow、SMA、RENAC、DELIOS、SAJ(CAN Comm) inverters, before connecting you need confirm that the DIP switch mode of the master module in Powerbox is 0010("# 3" to "ON" ,generally factory default is this 0010 mode).



(3) If the battery communicate with the Axpert/VMIII/MAX, Infinisolar, Growatt SPH(CAN comm)、GMDE, change the master module DIP switch to 0100("#2"to"ON") before connecting.



(4) If the battery communicate with the Growatt SPF HVM-P/ES/WPV by RS485 communication, change the master module DIP switch to 0110("#2"&"#3"to"ON") before connecting.



(5) If the battery communicates with the Schneider Conext Series, turn the master DIP switch "#1" and "#3" to "ON".



(6) When you setup the master DIP as setting 1~4, all the slaves keep the DIP 0000, no need change.

## Caution

Generally factory default DIP switch status of the master module in Powerbox Pro is setting 1. When they are used in parallel, all the slave Powerbox Pro systems need to be opened the cover and change the DIP switch of the master module to Slave Setting 1 (i.e. ADD: 0000), the master powerbox Pro no need change.

Proceed as follows:

- Remove the six screws on the Powerbox Pro and open the front panel.
- Find the red DIP switch on the master battery PCB .
- Change the DIP switch status to the original state (Mode5: i.e. ADD: 0000)
- Re-install the front panel with six screws which were removed in step a.

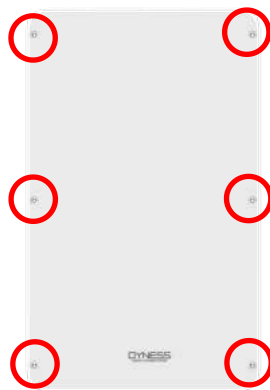

(a)

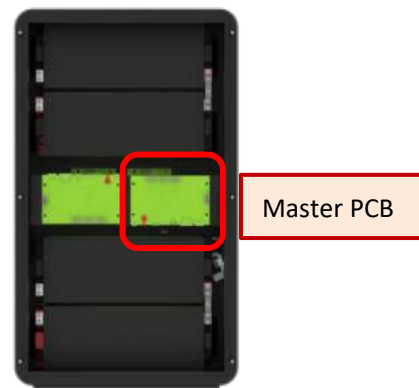

(b)



(c)

 **Caution:**

- Before connection, the positive and negative pole of the inverter input interface and the battery output interface should be confirmed.
- The red power line is connected to the positive pole and the black power line is connected to the negative pole.
- Before connection, it is necessary to confirm the charge and discharge parameters of the inverter interface.
- Voltage and current should meet the requirements of Table 2-2 battery performance parameters.
- When you use battery in parallel, it doesn't need to change the DIP switch of the master module in the master Powerbox which communicates with the inverter directly.
- Note: For more information of matching inverter brands, please subject to the latest document <The list of compatibility between Dy Ness ESS and Inverters >.
- The following operations can only be performed after being authorized by DYNESS:
- How to judge that the communication between the product is normal:
- If there is communication between the inverter and battery system, it can be judged by the maximum charge and discharge current value on the inverter sent by the battery.
  1. If there is communication between the inverter and battery system, it can be judged by the maximum charge and discharge current value on the inverter sent by the battery.
 
$$\frac{\text{(The maximum charge and discharge current value dispiled on the inverter)}}{\text{(The maximum charge and discharge current value of one battery module)}} = \text{number of modules}$$

If the equation holds after calculation, it means communication between the powerbox Pro is normal.
  2. If the Powerbox Pro light board shows three different colors flash alternately, it means the communication between Powerbox Pro is fault.

Table 3-5 Battery& Inverter power matching table

<b>Equipment Use</b>	Charging	a) The battery's long-term continuous charging current should be $\leq 0.5C$ b) If the battery remaining capacity is empty, please charge it within 48 hours after the battery is empty.
	Discharging	c) The long-term continuous discharge current of the battery should be $\leq 0.5C$ d) The recommend maximum depth of discharge (DOD)of Battery PACK is no more than 85%.

### 3.2.5 Battery parameter settings on the inverter

Max Charging(Bulk) Voltage: 57.6V

Absorption Voltage: 56.5V

Float Voltage: 56V

Shut Down(cut off) Voltage: 48V

Shut Down(cut off) SOC: 20%

Restart Voltage: 52V

Max Charge Current:100A

Max Discharge Current: 100A

Power of Hybrid Inverter/ Off-grid Inverter	Powerbox Pro	
	Type	System Energy(kWh)
5KW	1*powerbox Pro	10.24
10KW	2*powerbox Pro	20.48
15KW	3*powerbox Pro	30.72

### 3.2.6 Register on the website after installation

After the battery system installation is completed and the running is normal, you need to log in to the DYNES official website to register the product installation and use information to make the product warranty effective. Please follow the instructions on the website to register.

<http://www.dy ness-tech.com.cn>  Service  Sign Up

## 4 Use, maintenance and troubleshooting

---

### 4.1 Battery system usage and operation instructions

After completing the electrical installation, follow the instruction below to start the battery system.

1. Check whether the breaker is in OFF state.



2. Press the battery power button, the power button LED light is on, and 2 LED indicator lights will be on and show the green color after self-check.



### Caution:

- After pressing the power button, if the battery status indicator lights shows abnormally, please refer to the "4.2 Alarm description and processing". If the failure cannot be eliminated, please contact the retailer timely.
  - After pressing the power button, if the battery status indicator continues to be red, please refer to the "4.2 Alarm description and processing". If the failure cannot be eliminated, please contact the retailer timely.
-



3. Use a voltmeter to measure whether the voltage across the BAT + / BAT- terminals of the inverter is higher than 44.8V, and check whether the voltage polarity is consistent with the input polarity of the inverter. If the voltage across the terminals BAT + / BAT- of the inverter is higher than 44.8V, which means the battery has begun to work normally.
4. After confirm the battery output voltage and polarity are correct, turn on the inverter, then turn on the circuit breaker switch.
5. Check whether the indicator light for the inverter and the battery connection (the communication indicator and the battery access status indicator) is in normal condition. If normal, the connection between the battery and the inverter is completed. If the indicator light show abnormal, please check the inverter manual or contact the local dealer.

## 4.2 Alarm description and processing

When protection mode is activated or system failure occurred, the LED indicator on the front panel will alarm, through net management can query specific alarm class and take appropriate action.

### 4.2.1 Alarm and countermeasure for affecting system output

If there are any abnormalities affecting the output, such as battery cell in the battery module occurs over-current protection during charge/discharge, under-voltage protection, and temperature protection, in the system, please deal with them according to Table 4-1.

Table 4-1 Main alarm and Protection

Statue	Alarm category	Alarm indication	Processing
Charge state	Over-current when charging	RED light flashing Buzzer start	Reduce the charging current below the rated value.
	High temp protection	RED light flashing	Stop charging and find out the cause of the trouble.
Discharge state	Over-current protection when discharge	RED light flashing Buzzer start	Stop discharge and reduce discharge current below rated value.
	High temp protection when discharge	RED light flashing	Stop discharging and find out the cause of the trouble.
	Over-discharged protection	RED light flashing Buzzer start	Start charging.
	Low voltage alarm	Yellow light on	Start charging.

### 4.2.2 Alarm and countermeasure for non-affecting system output

If a low SOC alarm occurs, the battery system also issues a corresponding alarm signal. Maintainer should check the equipment according to the prompt information, determine the type and location of the fault, and take corresponding countermeasures to ensure that the system is in the best working condition to avoid affecting the system output. The phenomena and countermeasures are shown in Table 4-2.

Table 4-2 minor alarm

Alert category	Alarm indication	Countermeasure
$0% < \text{SOC} \leq 10\%$	System working status: yellow light is always on	Stop discharging, and charge the battery system in time.

### 4.3 Analysis and treatment of common faults

Table 4-3 Analysis and treatment of common faults

Item	Fault phenomenon	Reason analysis	Solution
1	The indicator does not respond after power on the system	Make sure press and hold the power switch (Reset switch) for 3s.	Check the power switch
2	No DC output after power on the system	Check if the DC breaker is turned on	Check the status of the DC circuit breaker on the side of cabinet
3	No DC output and red light is ON, buzzer beeping	Battery voltage is too low	Charging the battery system
4	The battery cannot be fully charged	Charging voltage is too low	Adjust charging voltage within 57.1V~57.6V range
5	The power cable sparks once power on and ALM indicated Red light on	Power connection short-circuit	Turn off the battery, check the cause of the short circuit
6	The master powerbox Pro LED1 is yellow flashing	Communication fault between product and product, or between internal modules in powerbox Pro	Check the external communication cable firstly, Check the internal communication cable secondly
7	The led 1,2 don't stop changing alternately	Modules comms address distribution is fault	Check the external comms cable connection firstly. Check the slave module DIP setting.

**If you need any technical help or have any question, please contact the dealer in time.**



Daqin New Energy Tech (Taizhou) Co., Ltd.  
Address: Building 13, Kunshan Jiangyan Industrial  
Park, Chenzhuang West Road, Jiangyan District,  
Taizhou City, Jiangsu Province, China, 225500.  
Email: [Sales@dyness-tech.com](mailto:Sales@dyness-tech.com)  
Website: [www.dyness-tech.com.cn](http://www.dyness-tech.com.cn)